

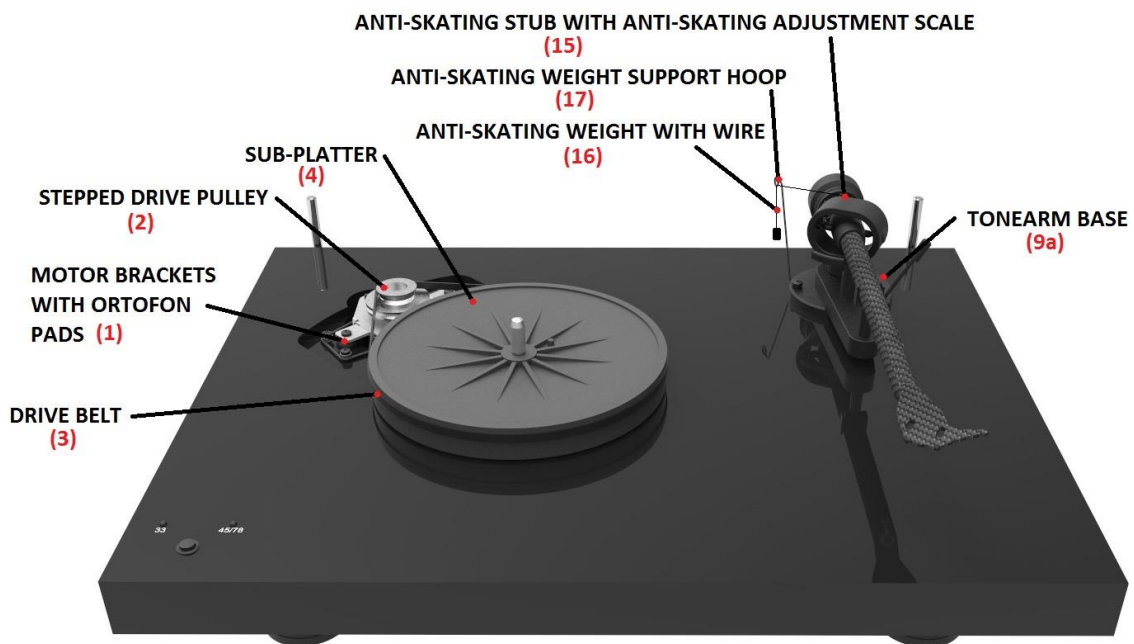

INSTRUCTIONS FOR USE
Pro-Ject Debut Carbon RecordMaster HiRes

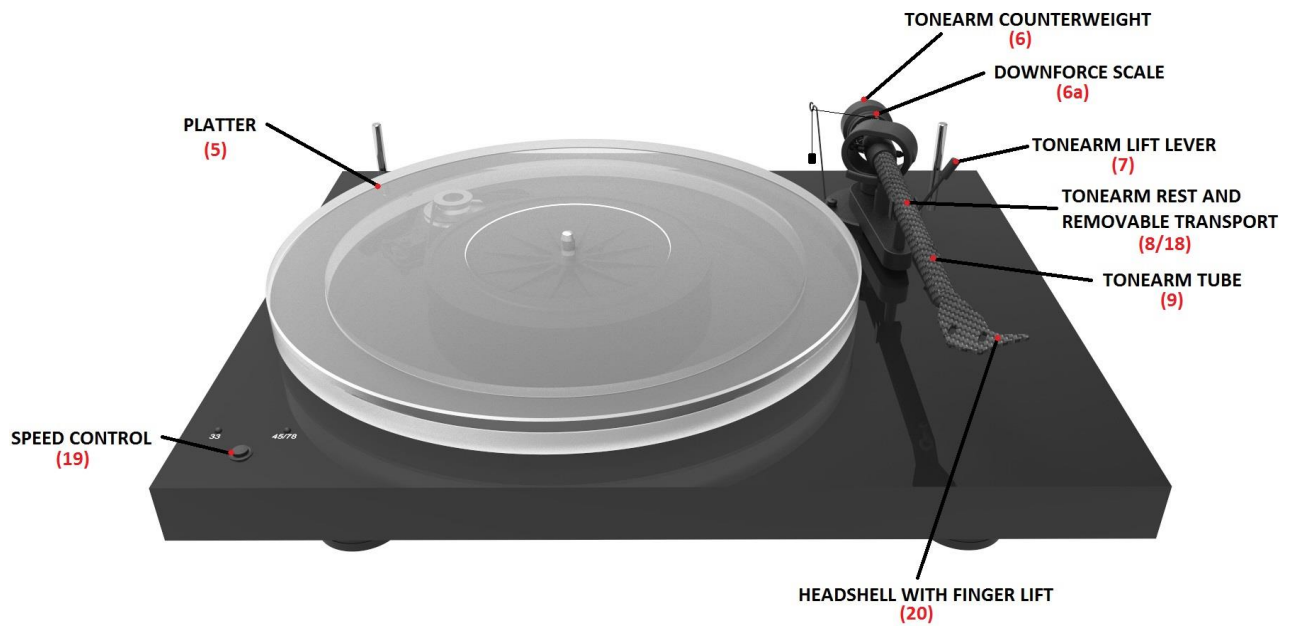

In order to achieve maximum performance and reliability with this record player you should study these instructions for use carefully.



Warning of a hazard for the user, the unit or possible misuse.



Important notice.

**** Your turntable has been delivered with a factory fitted and adjusted cartridge, please ignore the cartridge set up instructions unless changing the cartridge at a later date.**

During assembly and adjustment of the deck small parts could be lost if not carefully placed in a suitable receptacle. Before starting assembly make yourself acquainted with the parts listed above and correspondingly numbered in the technical drawings above. Separately packed items are marked with an asterisk *.

Safety instructions

Make sure that the plug and the switch are easily accessible at all times. Hold the plug when unplugging the power cord. Never handle the power cord while your hands are wet or damp.



Avoid letting liquids enter the device. Never place any item containing liquid, such as a flower vase on or near the device. Never spill any liquid on the device. Never place any naked flame sources, such as lighted candles on or near the device. The product shall not be used in damp or wet locations, next to a bathtub, sink, swimming pool or any other similar conditions.

Keep plastic bags away from children to prevent any risk of suffocation.

Set-up

The deck is supplied partially disassembled and carefully packaged for safe transport. Carefully remove all parts from the transport packaging.

Make sure the surface you wish to use the turntable on is level (use a spirit level) before placing the turntable on it. Remove the transport lock (18) from the tonearm. Store it in the original packaging so it is available for any future transportation.

Fit the drive belt (3) around the sub-platter (4) and the smaller diameter part of the motor pulley (2). Avoid getting sweat or grease on the belt as these will deteriorate the performance and reduce the belt's lifespan. Use absorbent kitchen paper to remove any oil or grease from the outer edge of the hub and the belt. Fit the platter (5) and felt mat over the spindle of the sub-platter (4).

Cartridge downforce adjustment

The counterweights (6) supplied are suitable for cartridges weighing between 4,5 - 6g (Ortofon OM 10 - weight no. 80) and 6,5 - 8,5g (Ortofon 2M Red - weight no. 8).

Pushing carefully, turn the counterweight (6) onto the rear end of the tonearm tube (9), so that the downforce scale (6a) shows towards the front of the player. Lower the armlift and position the cartridge in the space between arm rest and platter. Carefully rotate the counterweight (6) until the armtube balances out. The arm should return to the balanced position if it is moved up or down. This adjustment must be done carefully. Do not forget to remove the cartridge protection cap if fitted.

Once the arm is correctly balanced return it to the rest. Hold the counterweight (6) without moving it, and gently revolve the downforce scale ring (6a) until the zero is in line with the anti-skating prong (15). Check whether the arm still balances out.

Rotate the counterweight counter clockwise (seen from the front) to adjust the downforce according to the cartridge manufacturer's recommendations. One mark on the scale represents 1 mN (= 0,1g / 0,1 Pond) of downforce.



Please note: Adjust the downforce prior to installing the anti-skating weight.
 The recommended downforce for the Ortofon OM 10 cartridge is **15mN**.
 The recommended downforce for the Ortofon 2M Red cartridge is **17,5mN**.

Anti-skating force adjustment

The anti-skating force must be adjusted corresponding to the downforce as follows:

Downforce	Groove in the stub (15)
10 - 14mN	1 st from bearing rings
15 - 19mN	2 nd " " "
20mN and bigger	3 rd " " "

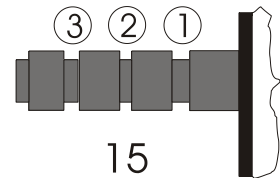

Slip the loop of the anti-skating weight's thread over the second groove of the stub to set the correct anti-skating force for the factory-fitted cartridge. Feed the thread through the loop of the wire support (17).

Input selector

Operating the push button **Phono/Line In** selects the inputs. **Phono** represents signal from tonearm of the turntable. **Line In** activates Line level input (RCA sockets).

ADC converter / Line level input

A line level signal source (e.g. tape deck or reel deck) can be connected to the built in preamplifier/ADC using **Line In** RCA socket. Integrated A/D converter relay the signal to digital data using optical **S/PDIF Out** or **USB** output (details about USB connection in a separate chapter).

Connection to the amplifier (Sound Bar, AV receiver etc.)

Use the analogue **Line Out** of the turntable to a line input (such as **AUX**, **CD**, **Tuner**, **Tape** or **Video**) on your amplifier.

Alternatively built in ADC converter allows to relay signal in digital format out of the amplifier using **S/PDIF Out** digital output to the corresponding digital input of the amplifier or digital input of any Sound Bar, AV-receiver etc.

Connecting to a computer / USB output

Connect the **USB Out** of the unit to a free USB-socket on your computer. Make sure the computer is powered on.

* For Windows® operating systems an USB Class 2 driver (supplied on CD) has to be installed.

Mac OS® operating systems do not need an additional driver or setup.

Linux operating systems include an USB Audio Class 2 driver from Linux Kernel 2.6.35 and higher.



Please note: Connection should be made to an USB-socket of your computer directly. Connecting to USB-hubs or switches can cause problems.

Recording program is delivered on supplied CD-ROM together with USB driver Vinylstudio Lite (software from British specialist AlpineSoft)

Sampling rate of USB output is set from computer

Setting the record level

The **Record Level** knob on the rear panel is used to set the level of the analogue signal going to the A/D converter. A red clipping LED indicates when the level is too high and the signal is distorted. Make sure that level is set to keep the LED off all the time.

Vinylstudio settings

RecordMaster firmware v1.01

- RecordMaster allows following record settings:

1. Pulse-code modulation (PCM):
 - 16/24/32-bits at 44.1k / 48k / 88.2k / 96k / 192kHz / 384kHz
2. Direct Stream Digital (DSD) over PCM (DoP):
 - DSD standard rate: DSD64 at sample rate 176.4kHz
 - DSD double rate: DSD128 at sample rate 352.8kHz
 - DSD quad rate: DSD256 at sample rate 705.6kHz

- VinylStudio Lite record setting:

Check Level:

- **Input Device:** ASIO
- **ASIO Driver:** Project Box ASIO Driver
- **DSD Input:** PCM or DSD (depends on Recording **Options**)

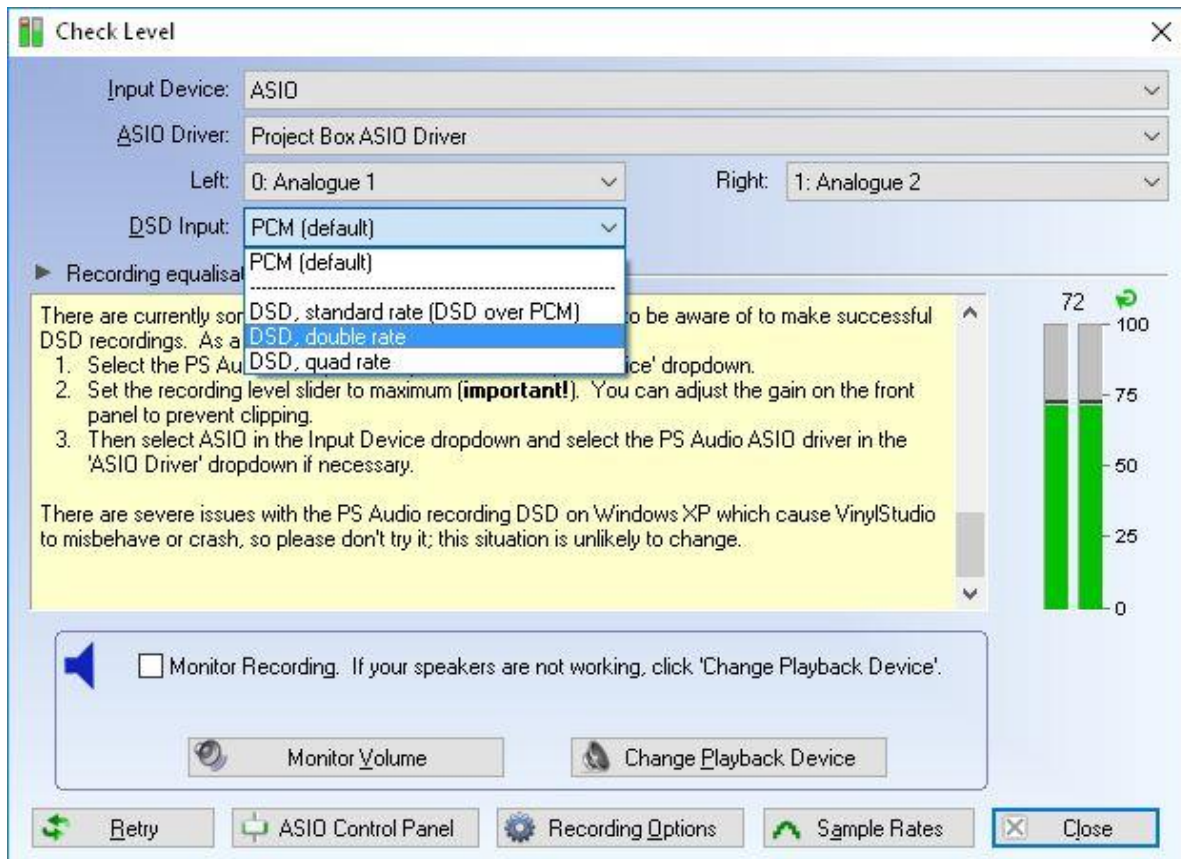

Recording Options:

- AIFF format:

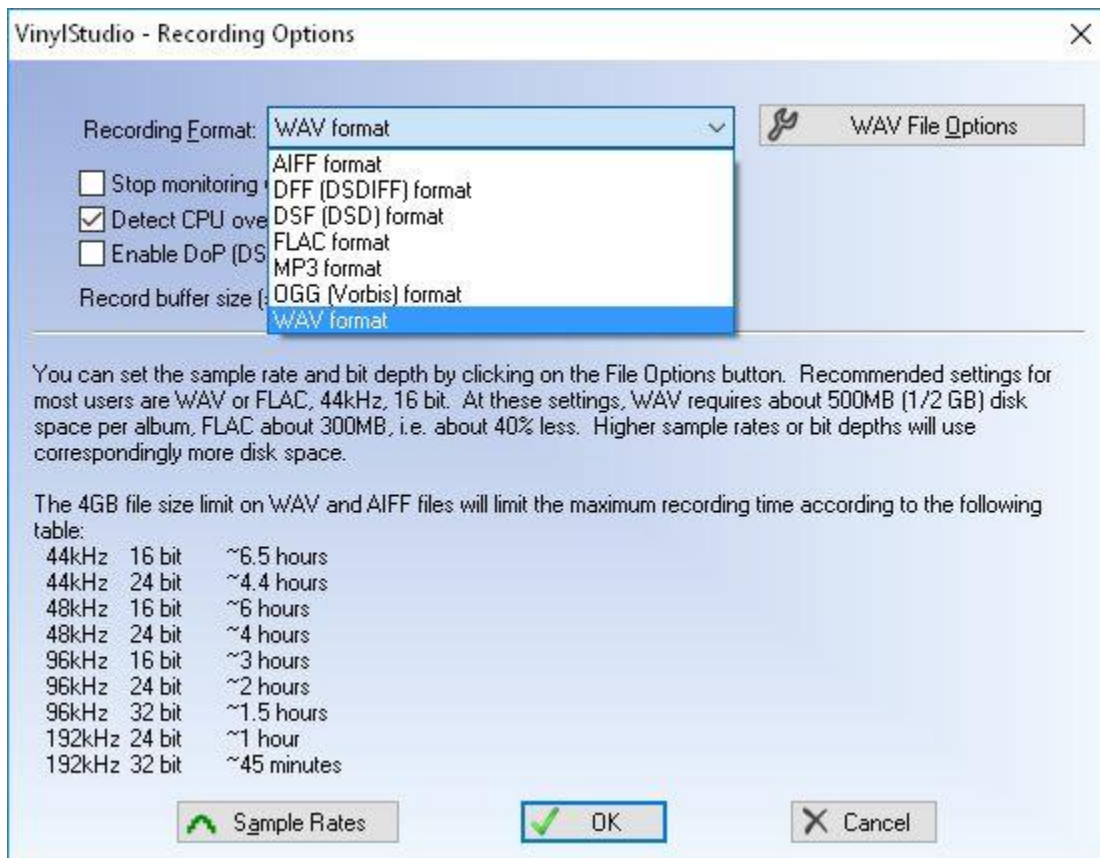

- AIFF PCM format:

- **Check Level:** DSD Input: PCM
 - **Recording Options:**
 - Disable DoP detection
 - Sample Rate: 44.1k / 48k / 88.2k / 96k / 192kHz / 384kHz
 - Bit Depth: 16/24/32-bits
- **AIFF DSD format:**
 - **Check Level:** DSD Input: DSD standard / double / quad rate
 - **Recording Options:**
 - Enable DoP detection
 - Sample Rate: DSD standard / double / quad rate
 - Bit Depth: N/A (24-bits PCM)
- **DFF format:**
 - **Check Level:** DSD Input: DSD standard / double / quad rate
 - **Recording Options:**
 - Enable DoP detection
 - DSD Rate: DSD standard / double / quad rate
- **DSF format:**
 - **Check Level:** DSD Input: DSD standard / double / quad rate
 - **Recording Options:**
 - Enable DoP detection
 - DSD Rate: DSD standard / double / quad rate
- **FLAC format:**
 - Available with full license only!
- **FLAC PCM format:**
 - **Check Level:** DSD Input: PCM
 - **Recording Options:**
 - Disable DoP detection
 - Sample Rate: 44.1k / 48k / 88.2k / 96k / 192kHz / 384kHz
 - Bit Depth: 16/24/32-bits
 - Compression: 0-8
- **FLAC DSD format:**
 - **Check Level:** DSD Input: DSD standard / double / quad rate
 - **Recording Options:**
 - Enable DoP detection
 - Sample Rate: DSD standard / double / quad rate
 - Bit Depth: N/A (24-bits PCM)
 - Compression: 0-8
- **MP3 format:**
 - LAME MP3 Encoder installation and localization required!
 - **Check Level:** DSD Input: PCM
 - **Recording Options:**
 - Disable DoP detection
 - Sample Rate: 44.1k / 48kHz
 - MP3 Quality: CBR@16-320kbps, ABR@16-320kbps, VBR@0-9
- **OGG format:**
 - **Check Level:** DSD Input: PCM
 - **Recording Options:**
 - Disable DoP detection
 - Sample Rate: 44.1k / 48kHz
 - Quality: ABR@48-448kbps, VBR@0-10

- WAV format:
 - WAV PCM format:
 - **Check Level:** DSD Input: PCM
 - **Recording Options:**
 - Disable DoP detection
 - Sample Rate: 44.1k / 48k / 88.2k / 96k / 192kHz / 384kHz
 - Bit Depth: 16/24/32-bits
 - WAV DSD format:
 - **Check Level:** DSD Input: DSD standard / double / quad rate
 - **Recording Options:**
 - Enable DoP detection
 - Sample Rate: DSD standard / double / quad rate
 - Bit Depth: N/A (24-bits PCM)

Change Playback Device:

- If ASIO is used as input device, then playback device can't run on the same driver. i.e.: if Pro-Ject USB audio driver shows more connected devices (on the screenshot below is Device 0 – Recordmaster, Device 1 Maia DS) Then the second device can't be selected as a playback device for **Monitor Recording**.

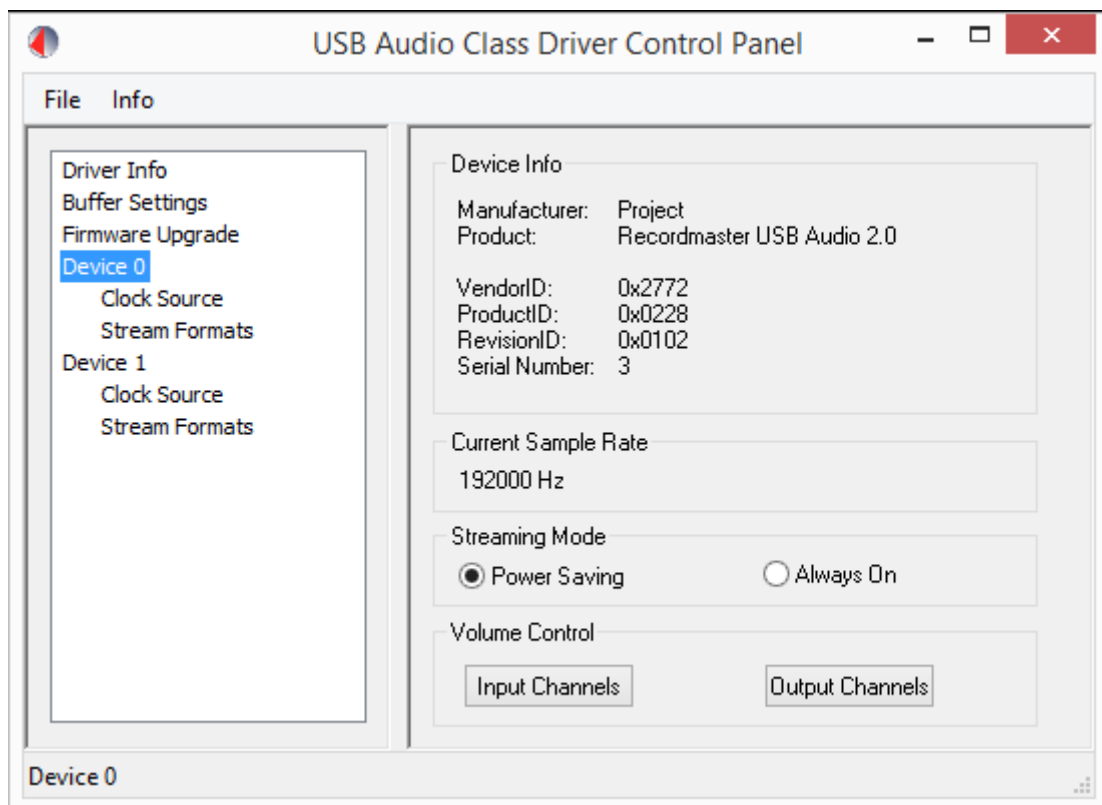

- Do not use **Monitor Recording**, if playback device is recordmaster to avoid mixing signals in optical output
- **Monitor Recording** can be used for any other playback device available in **Playback To** list (except the case of ASIO described above):



In case of no sound of Monitor Recording try to restart playback USB device. (Do not reconnect USB cable when units are powered on).

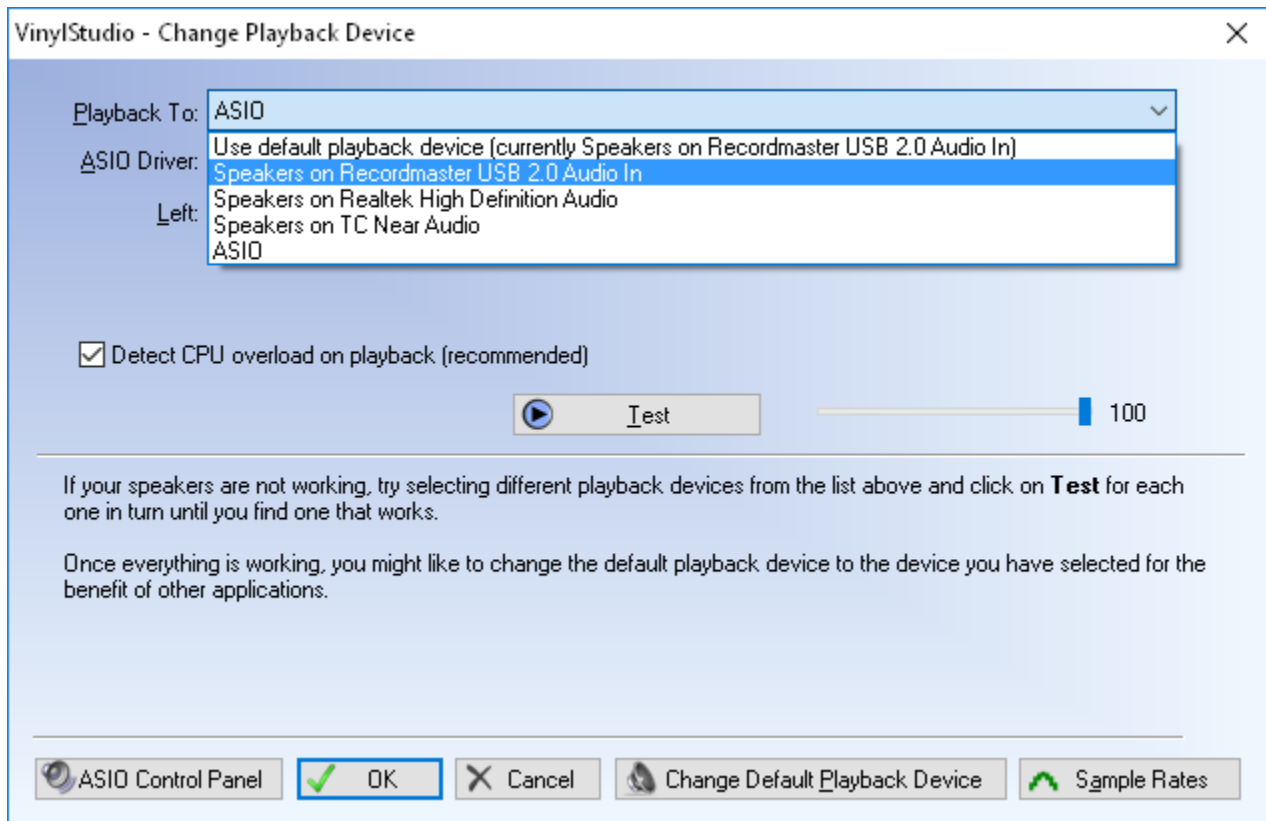

DSD records playback:

- **AIFF, FLAC, WAV format:**
 - These DSD files with DSD data and DoP markers are possible to play on DACs with ASIO DoP Marker 0x05/0xFA support
- **DFF, DSF format:**
 - These files don't contain DoP markers (Native DSD format), playback is possible with suitable DAC's with ASIO Native DSD support and also with DAC's with ASIO DoP Marker 0x05/0xFA support if playback software allows this (e.g.: J-River or Foobar2000 with plugin foo_dsd_asio)

Setting of a recording device in Windows 7/8/10:

Start > Control Panel > Sound > Recording

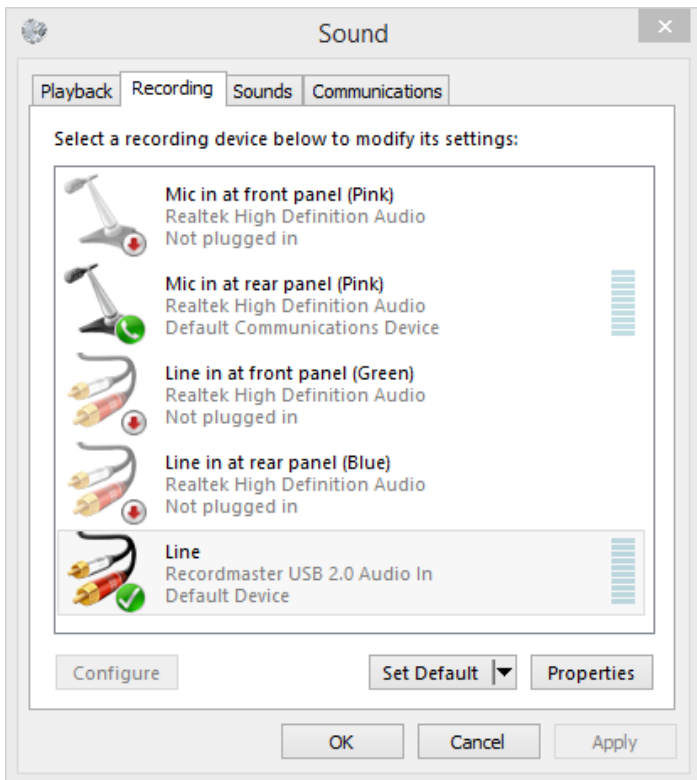

Select – RecordMaster USB 2.0 Audio In – and go to Properties > Listen

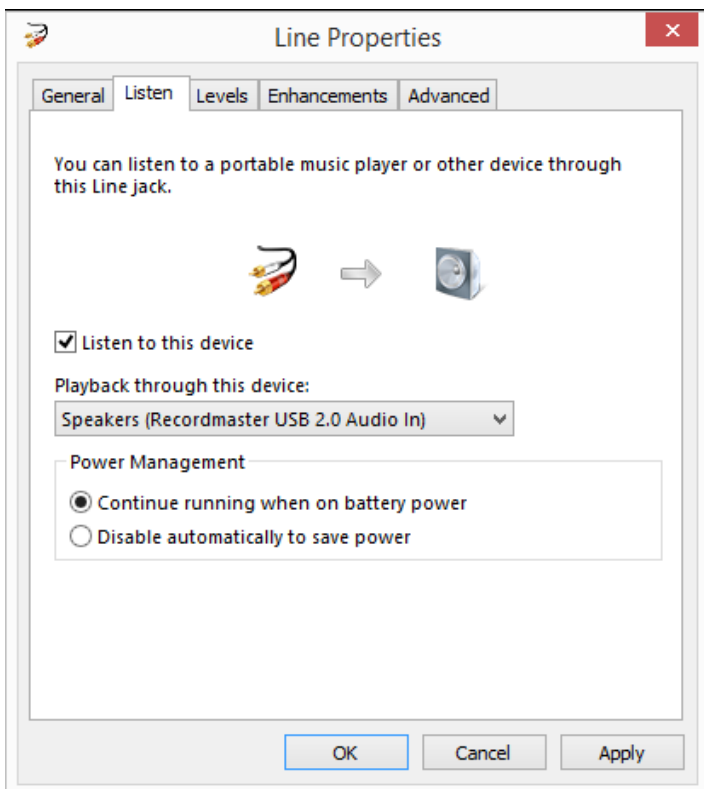

Go to Advanced and select desired sample rate and bit depth

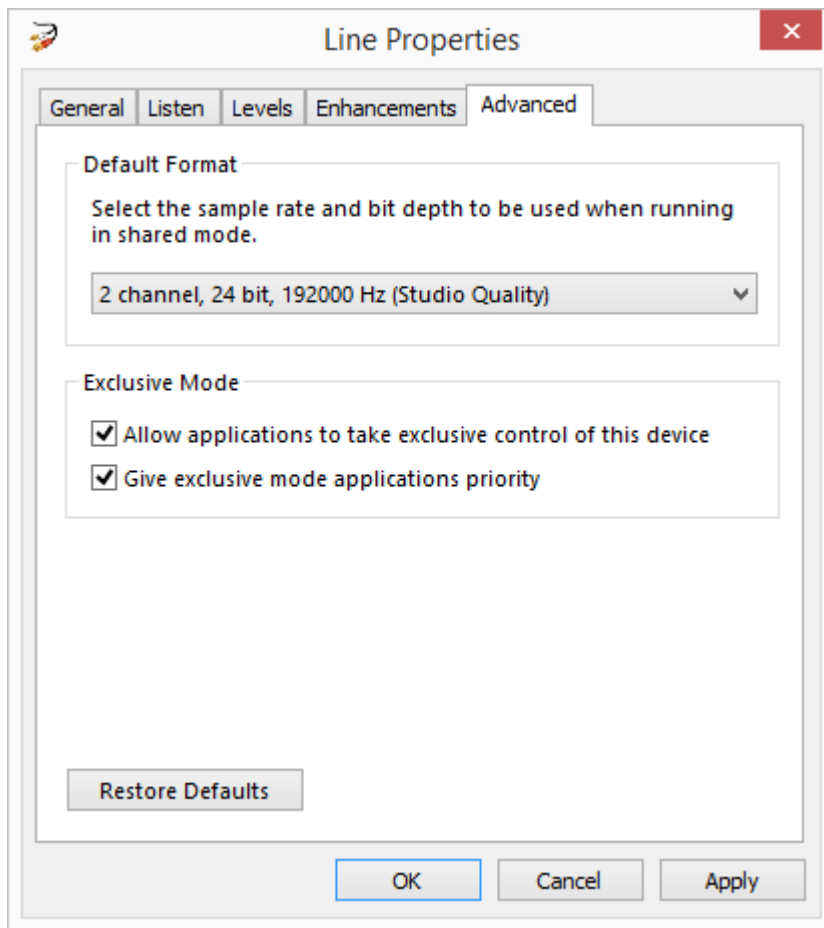

Mains power connection

The turntable is supplied with the universal power supply with 3 exchangeable sockets adapters suitable for all countries. Select the correct adapter for your country and insert the adapter to the exchangeable part of the power supply.

Connect the low voltage plug from the power supply to the socket (13) on the rear of the record player before connecting the power supply to the mains.

Fitting the lid

Fit the lid (dust cover 10) carefully over the hinge prongs and adjust the screws (12) until the lid stays open where you want it to without being too stiff to open or close.

Switching on and off, changing replay speed

To play records at 33 r.p.m. press the ON/OFF switch (19) to start the motor. Pressing the ON/OFF switch two times selects 45 r.p.m.. The selected speed is shown respectively by the flashing LED. When the platter has attained full speed the LEDs stop flashing.

To be able to play 78 r.p.m. the flat drive belt has to be removed and the round drive belt has to be fitted around the sub-platter (4) and the larger diameter part of the motor pulley (2). To do so the platter (5) has to be removed.

After the round drive belt has been fitted, pressing the ON/OFF switch two times selects 78 r.p.m.. When full speed is attained the LED **45** stops flashing.

A long (more than three seconds) press on the ON/OFF switch stops the motor.

Useful tips

The record player should be positioned on a low-resonance surface such as wood or multiple layer ply board to avoid structural vibrations disturbing replay.

Adjusting the azimuth

** The cartridge needle must be vertical in the record groove in order to trace the groove wall modulations correctly.

A small screw at the bearing end of the arm allows incorrect azimuth to be corrected if your needle is not mounted exactly perpendicular to the cartridge body (which is often the case).

Slacken off the screw just enough to be able to revolve the arm tube without applying force. Please note: do not remove the screw completely!

With the aid of a good magnifying glass adjust the needle until it is vertical in the groove (i.e. perpendicular to the record's surface). Ideally this should correspond to the top surface of the cartridge body being parallel to the record surface.

When you are satisfied that the needle is vertical retighten the screw carefully.

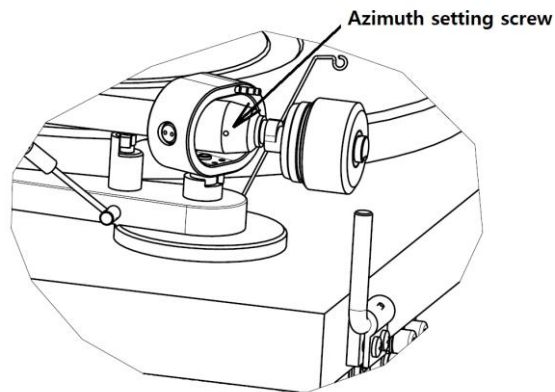

Please note: Under no circumstances should the arm tube be adjusted with the needle still in the record groove! Irreparable damage may be caused to the cantilever suspension! The arm must be lifted to make each adjustment and lowered afterwards to check it.

Mounting and connecting the cartridge

** All cartridges with half inch mounting holes can be fitted. Leaving the needle's protection cover on, fit the cartridge to the headshell using the screws supplied with the cartridge by passing one screw through each slot in the headshell (20). Do not tighten the nuts yet.

Connect the tonearm wires to the cartridge pins as follows:

white	left channel positive (L+)
red	right channel pos. (R+)
green	right channel return (R -)
blue	left channel return (L -)

The full sound quality of the record player can only be achieved if the cartridge is correctly adjusted. Particular tools like the Pro-Ject alignment tool are required to accomplish this job properly.

If you are not well acquainted with the adjustment of cartridges you are advised to call upon the willing help of your Pro-Ject dealer to accomplish this task for you.



Please note: Adjusting a cartridge and tonearm calls for the greatest care in order to avoid damaging the cartridge or tonearm bearings. Leave this work to your dealer if you are in any way unsure of the necessary steps and precautions to be taken.

Maintenance and cleaning

Your record player requires little or no regular maintenance. Remove dust with a slightly moistened antistatic cloth. Never use a dry cloth because this will create static electricity which attract more dust! Antistatic

cleaning fluids are available at specialist stores but must be applied sparingly to avoid damage to rubber parts. It is recommended to fit the needle cover before cleaning or maintenance is carried out to avoid damage. If the player is not used over a long period of time the drive belt can be removed to prevent unequal stretching.



Always disconnect the record player from the mains power supply as a precaution before maintenance!

Technical specifications

Pro-Ject Debut Carbon RecordMaster HiRes/ Pro-Ject 8.6cc

Nominal speeds	33/45 r.p.m.. *** 78 r.p.m. optional
Speed variance	33: 0,60% 45: 0,50%
Wow and flutter	33: 0,29% 45: 0,27%
Signal to noise	-68dB
Effective tonearm mass	6g
Effective tonearm length	8,6 " (218,5mm)
Overhang	18,5mm
Power consumption	4W/0W in Stand-By
Outboard power supply	15V / 0 – 0.8mA DC (set at 0.5mA), universal power supply
Dimensions (W x H x D)	415 x 118 x 320mm, dust cover open 415 x 365 x 405mm
Weight	5,6kg

Technical specifications MM-Cartridge Ortofon 2M Red

Frequency range	20-22.000Hz
Channel separation	22dB/1kHz
Output voltage	5,5mV
Recommended load impedance	47kohms/amplifier connection – MM-input
Compliance/stylus type	20µm/mN – elliptical
Recommended tracking force	18mN
Weight	7,2g

Potential incorrect use and fault conditions

Pro-Ject turntables are manufactured to the highest standards and undergo strict quality controls before leaving the factory. Faults that may possibly occur are not necessarily due to material or production faults but can sometimes be caused by incorrect use or unfortunate circumstances. Therefore the following list of common fault symptoms is included.

The platter doesn't turn although the unit is switched on:

- The unit is not connected to the mains power supply.
- No mains at the socket.
- Drive belt is not fitted or has slipped off.

No signal through one or other channel or both channels:

- No signal contact from the cartridge to the internal tonearm wiring or from that to the arm lead or from that to the phono box or between that and the amplifier. This could be due to a faulty plug, broken wire or solder joint or simply loose plug/socket connection.
- Phono input not selected at amplifier.
- Amplifier not switched on.
- Amplifier or speakers defective or muted.
- No connection to the loudspeakers.

Strong hum on phono input:

- No earth connection from cartridge or arm or arm cable to amplifier, or earth loop.

Distorted or inconsistent sound from one or both channels:

- Record player is connected to wrong input of amplifier, or MM/MC switch incorrectly set.
- Needle or cantilever damaged.
- Wrong r.p.m., drive belt overstretched or dirty, platter bearing without oil, dirty or damaged.

Service

Should you encounter a problem which you are not able to alleviate or identify despite the above information, please contact your dealer for further advice. Only when the problem cannot be resolved there should the unit be sent to the responsible distributor in your country.

Guarantee repairs will only be effected if the unit is returned correctly packaged. For this reason we recommend keeping the original packaging.

Never return a record player without making sure that it is safely disassembled and correctly packaged in the original packaging according to the diagrams on the last page of this user guide. Please remove these parts and pack them separately: lid (10), counterweight (6), anti-skating weight (16) platter (5) and belt (3). Fit the cartridge protection cap. Insert the transport lock for the tonearm (18) prior to carefully packaging the record player.

Warranty



The manufacturer accepts no responsibility for damage caused by not adhering to these instructions for use and/or by transportation without the original packaging. Modification or change to any part of the product by unauthorized persons release the manufacturer from any liability over and above the lawful rights of the customer.

Pro-Ject Audio Systems is a Registered Trademark of H. Lichtenegger.

This guide was produced by: Pro-Ject Audio Systems
Copyright © 2017. All rights reserved.

The information was correct at the time of going to press. The manufacturer reserves the right to make changes to the technical specification without prior notice as deemed necessary to uphold the ongoing process of technical development.

